

euroStream™



**2023** PRODUCT GUIDE  
GUIDE DE PRODUITS



**It All Start Here  
Style, Design, Value**

**Tout commence ici  
Style, Design, Valeur**

Since 1990, Eurostream® has been designing and manufacturing an extensive range of decorative plumbing products from faucets and bath accessories, to showerheads and vanities. We have built a reputation for delivering high-quality products with exceptional design, serviced by a team of dedicated professionals around the globe. We are passionate about our products, committed to delivering meaningful solutions for our customers, and dedicated to make a positive impact on the people we meet each and every day.

Depuis 1990, Eurostream<sup>MD</sup> a conçu et fabriqué une vaste gamme de produits de plomberie décoratifs allant des robinets et des accessoires de salles de bain aux pommes de douche et des meubles-lavabos. Nous avons acquis la réputation de fournir des produits de haute qualité avec un design exceptionnel, entretenus par une équipe de professionnels dévoués dans le monde entier. Nous sommes passionnés par nos produits, nous nous engageons à fournir des solutions significatives à nos clients et nous nous engageons à avoir un impact positif sur les personnes que nous rencontrons chaque jour.



**EZ ConX® TOP MOUNT Kitchen pull down or pull out installation in less than 5 minutes**  
**Montage supérieur EZ ConX<sup>MD</sup> L'installation d'un robinet de cuisine à bec rétractable ou extensible en moins de 5 minutes**



To watch vedio



Drop the base  
Insérer la base



Secure to the deck  
La fixer au comptoir



Fit body on the base  
Glisser le corps sur la base



Secure body to the base  
Fixer le corps à la base



**Push-fit water inlet connectors**  
**Raccordement rapide des conduits d'alimentation en eau**

Innovative self-aligned push-fit connections make installation trouble-free.  
 The click sound provide an instant feedback that your connection is robustic.

Le raccordement rapide fournit un joint étanche à l'eau sans outils ou ruban adhésif. Seul un simple raccord de tuyau en une pièce relie les valves d'extrémité aux becs facilitant ainsi une installation rapide et facile.



To watch vedio

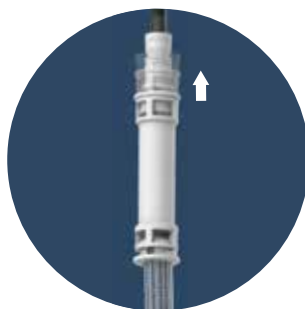



## Fast & easy install drain Drain à installation rapide et facile

### EZ ConX® Push Pop Up Drain Assembly / EZ ConX<sup>MD</sup> Ensemble de vidange à bonde-poussoir

Above sink quick install / Installation rapide dans le lavabo

Easy cleaning / Facile à nettoyer



1 Drop / Insérer



2 Twist / Tourner



### EZ ConX® Pop Up Drain Assembly / EZ ConX<sup>MD</sup> Ensemble de vidange escamotable

Above sink quick install / Installation rapide dans le lavabo



1 Drop & lock / Insérer et fixer

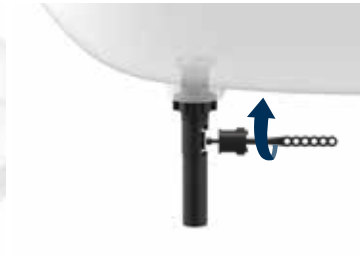

2 lock / Fixer

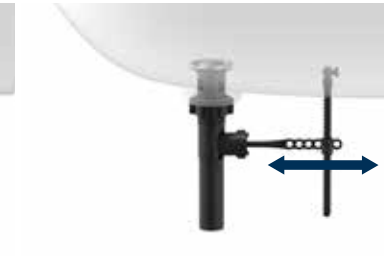

3 adjust / Régler

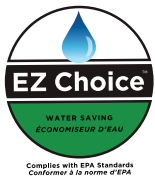

## Water Saving Économiseur d'eau

Our products that have the EZ Choice<sup>®</sup> Water saving logo comply with EPA standards that reduce water flow to 1.5 gpm, resulting in water conservation of up to 32%.

Nos produits qui portent le logo EZ Choice<sup>MD</sup> économiseur d'eau sont conformes aux normes de l'EPA sur la réduction de débit d'eau à 1,5 gpm, permettant une conservation de l'eau jusqu'à 32%.





# Pressure Balance Tub & Shower Valve Robinet de bain et de douche à pression équilibrée

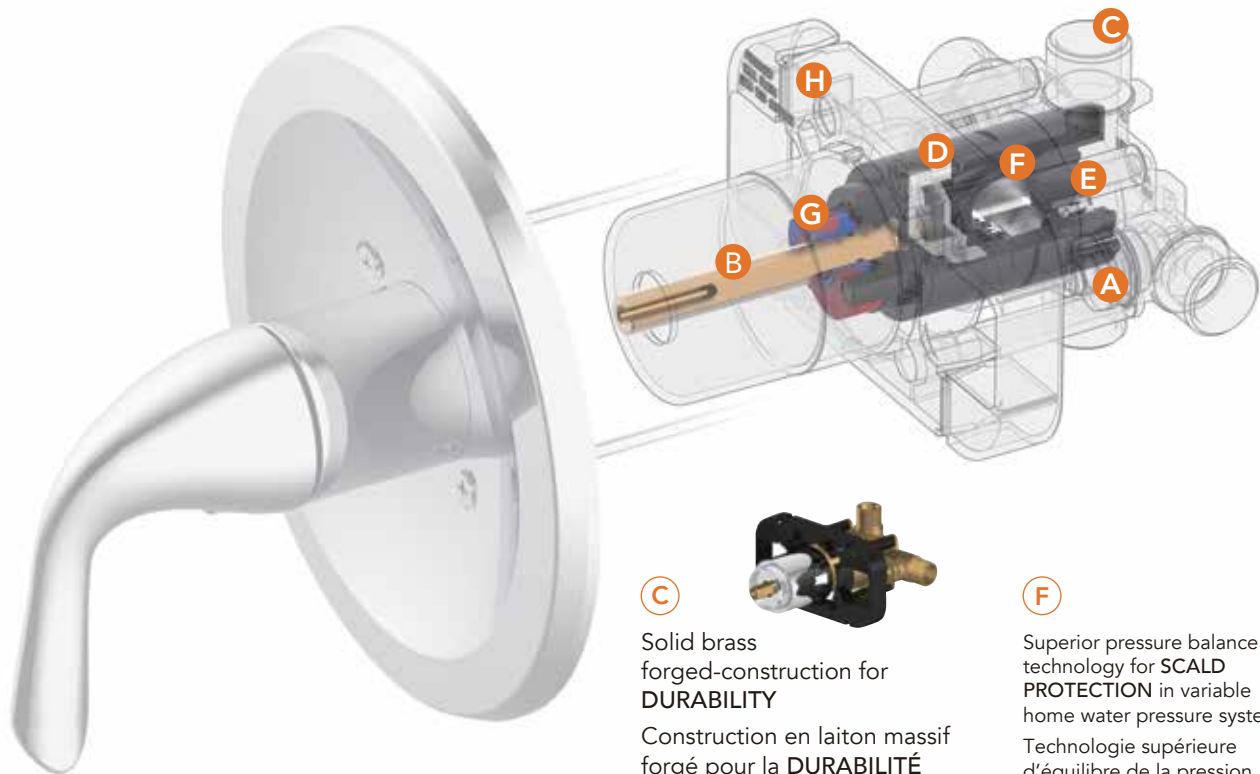

**C**

Solid brass  
forged-construction for  
**DURABILITY**

Construction en laiton massif  
forgé pour la **DURABILITÉ**

**F**

Superior pressure balance  
technology for **SCALD  
PROTECTION** in variable  
home water pressure systems

Technologie supérieure  
d'équilibre de la pression  
pour

**PROTÉGER CONTRE LES  
ÉCHAUDURES** dans les  
réseaux d'eau à pression  
variables

**A**

**EASY ACCESS** integrated  
stops for turning off water  
at the valve for repair

Soupapes d'arrêt  
incorporées **FACILES  
D'ACCÈS** pour couper  
l'arrivée d'eau de la valve  
pour les réparations



**D**

Equipped with new  
**SELF LUBRICATING** Ceramic  
Technology for smooth,  
drip-free operation!

Nouvelle technologie  
céramique **AUTOLUBRIFIANTE**  
pour un fonctionnement en  
douceur et antigoutte!



**G**

**ADJUSTABLE**  
temperature limit

Limiteur de température  
**RÉGLABLE**

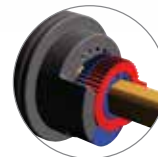

**B**

**EASY** Back-to-Back feature  
included for efficient  
adjacent bathroom  
installation

Dispositif dos à dos  
**SIMPLE** pour installation  
efficace d'une salle de  
bain adjacente



**E**

Integrated **BACK FLOW  
PREVENTION** mechanism (all  
serviceable components within  
the cartridge)

Mécanisme de **PRÉVENTION  
DES RETOURS D'EAU** incorporé  
(tous les éléments fonctionnels  
sont dans la cartouche)



**H**

**COMPACT** size valve and  
valve-locator plate provide  
good accessibility during  
installation

Valve **COMPACTE** et  
châssis de valve facilitant  
l'accès pendant l'installation

# Kitchen

## Easy and Smart Features Les caractéristiques faciles et intelligentes

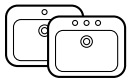

Fits 1 or 3 hole sinks  
Pour évier à 1 ou 3 trous

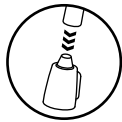

Pull-down sprayer  
Douchette extensible



Pull-out sprayer  
Douchette rétractable



Supply lines included  
Conduites d'alimentation incluses



EZ ConX<sup>®</sup>  
Top Mount installation  
EZ ConX<sup>MD</sup>  
Support de montage supérieur



EZ ConX<sup>®</sup> Hose connection  
Raccord de tuyau EZ ConX<sup>MD</sup>

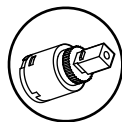

Ceramic disc cartridge  
Cartouche de disque en céramique

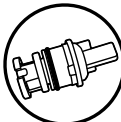

Washerless cartridge  
Cartouche sans rondelle

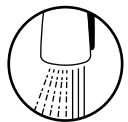

Dual function sprayer  
Douchette à double fonction



Convenient on-deck spray  
Douchette pratique sur l'applique

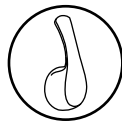

Metal lever handle  
Manette à levier en métal

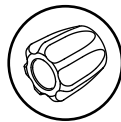

Acrylic handles  
Poignées en acrylique

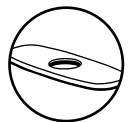

Optional deck plate  
Applique facultative



Lead free  
Sans plomb



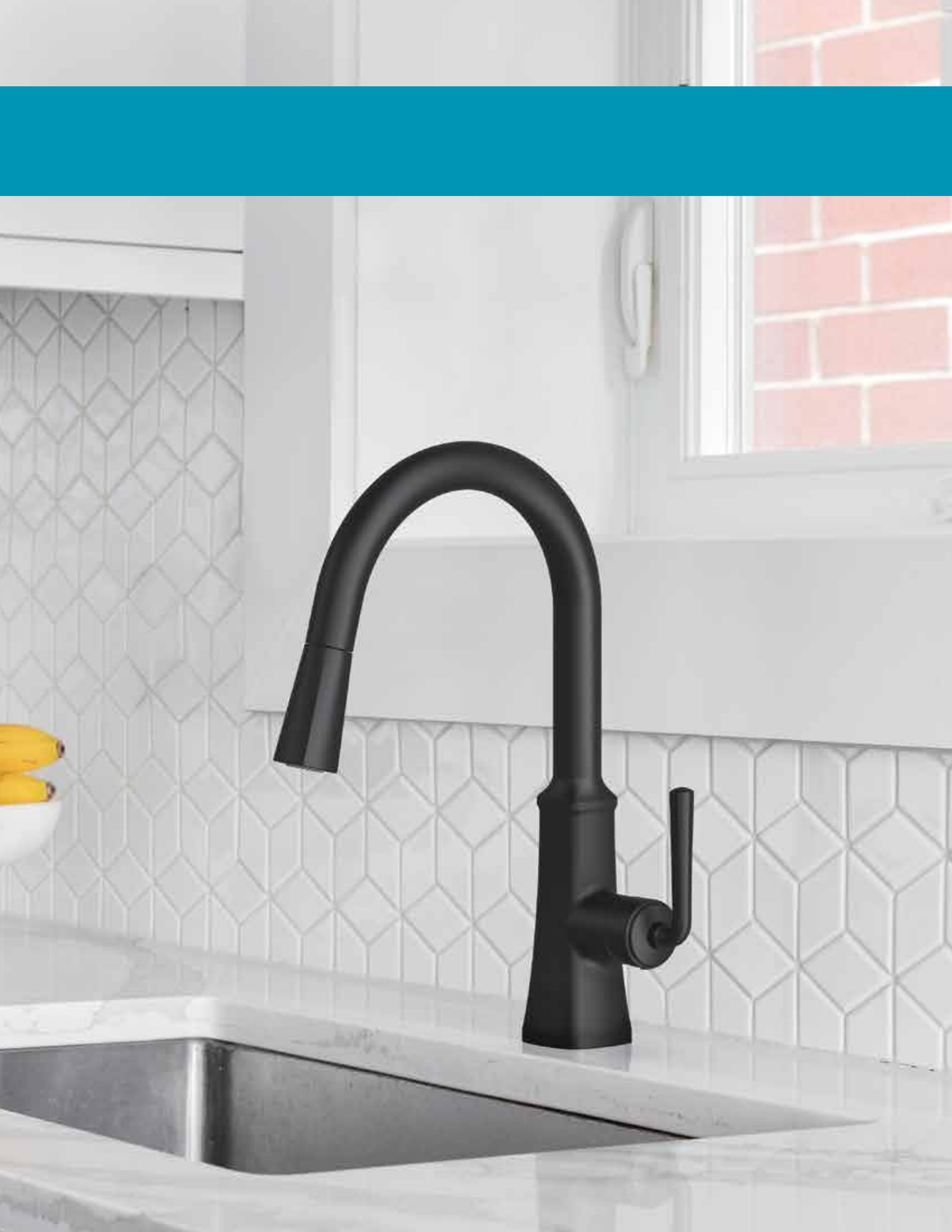

# Pull down faucet





# Adessa



3227-324  
FP4A0118CZ



3230-130  
FP4A0118CP



3230-129  
FP4A0118NP



3228-020  
FP4A0118BL

## Easy and Smart Features Les caractéristiques faciles et intelligentes

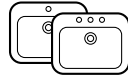

Fits 1 or 3 hole  
sinks

Pour éviers à 1  
ou 3 trous

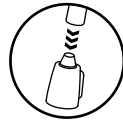

Pull-down  
sprayer

Douchette  
extensible

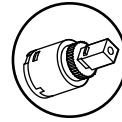

Ceramic disc  
cartridge

Cartouche  
de disque en  
céramique



Supply lines  
included

Conduites  
d'alimentation  
incluses

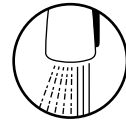

Dual function  
sprayer

Douchette  
à double  
fonction



EZ ConX<sup>®</sup>  
Top Mount  
installation  
EZ ConX<sup>MD</sup>  
Support de  
montage  
supérieur



EZ ConX<sup>®</sup> Hose  
connection  
Raccord  
de tuyau  
EZ ConX<sup>MD</sup>

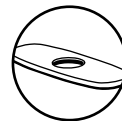

Optional deck  
plate

Applique  
facultative



Lead free  
Sans plomb

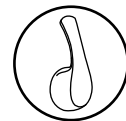

Metal lever  
handle

Manette à  
levier en métal

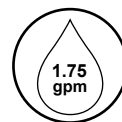

Maximum flow  
rate of 1.75  
gpm at 60 psi

Débit  
maximum de  
1,75 gpm à 60  
psi

# Paramous



3227-322  
FP1B4228CP

3227-323  
FP1B4228BL

## Easy and Smart Features Les caractéristiques faciles et intelligentes

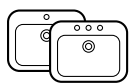

Fits 1 or 3 hole  
sinks

Pour évier à 1  
ou 3 trous

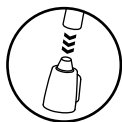

Pull-down  
sprayer

Douchette  
extensible

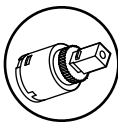

Ceramic disc  
cartridge

Cartouche  
de disque en  
céramique



Supply lines  
included

Conduites  
d'alimentation  
incluses



EZ ConX®  
Top Mount  
installation  
EZ ConX<sup>MD</sup>  
Support de  
montage  
supérieur



EZ ConX® Hose  
connection

Raccord  
de tuyau  
EZ ConX<sup>MD</sup>

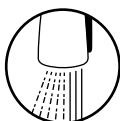

Dual function  
sprayer

Douchette  
à double  
fonction

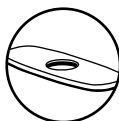

Optional deck  
plate

Applique  
facultative



Lead free  
Sans plomb

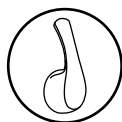

Metal lever  
handle  
Manette à  
levier en métal



Maximum flow  
rate of 1.75  
gpm at 60 psi

Débit  
maximum de  
1,75 gpm à 60  
psi





# Siete



3227-320  
FP1B4229CP



3227-321  
FP1B4229BL

## Easy and Smart Features Les caractéristiques faciles et intelligentes

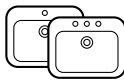

Fits 1 or 3 hole sinks  
Pour évier à 1 ou 3 trous



Pull-down sprayer  
Douchette extensible

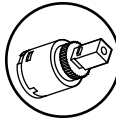

Ceramic disc cartridge  
Cartouche de disque en céramique



Supply lines included  
Conduites d'alimentation incluses



EZ ConX<sup>®</sup>  
Top Mount installation  
EZ ConX<sup>MD</sup>  
Support de montage supérieur



EZ ConX<sup>®</sup> Hose connection  
Raccord de tuyau EZ ConX<sup>MD</sup>

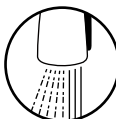

Dual function sprayer  
Douchette à double fonction



Optional deck plate  
Applique facultative



Lead free  
Sans plomb



Metal lever handle  
Manette à levier en métal



Maximum flow rate of 1.75 gpm at 60 psi  
Débit maximum de 1,75 gpm à 60 psi

# Everard



3228-021  
FP4AF278CP



3228-022  
FP4AF278NP

## Easy and Smart Features Les caractéristiques faciles et intelligentes

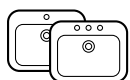

Fits 1 or 3 hole sinks

Pour évier à 1 ou 3 trous

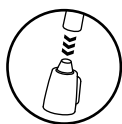

Pull-down sprayer

Douchette extensible

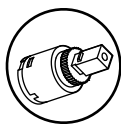

Ceramic disc cartridge

Cartouche de disque en céramique



Supply lines included

Conduites d'alimentation incluses



EZ ConX<sup>®</sup> Hose connection

Raccord de tuyau EZ ConX<sup>MD</sup>

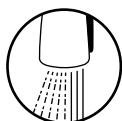

Dual function sprayer

Douchette à double fonction

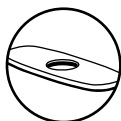

Optional deck plate

Applique facultative



Lead free  
Sans plomb

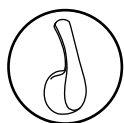

Metal lever handle

Manette à levier en métal



Maximum flow rate of 1.75 gpm at 60 psi

Débit maximum de 1,75 gpm à 60 psi







# Whitley



3228-024  
FP4AF279CP



3228-025  
FP4AF279NP



3228-023  
FP4AF279BL

## Easy and Smart Features Les caractéristiques faciles et intelligentes

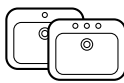

Fits 1 or 3 hole sinks  
Pour évier à 1 ou 3 trous

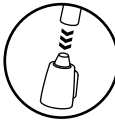

Pull-down sprayer  
Douchette extensible

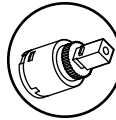

Ceramic disc cartridge  
Cartouche de disque en céramique



Supply lines included  
Conduites d'alimentation incluses



EZ ConX<sup>®</sup>  
Top Mount installation  
EZ ConX<sup>MD</sup>  
Support de montage supérieur



EZ ConX<sup>®</sup> Hose connection  
Raccord de tuyau EZ ConX<sup>MD</sup>

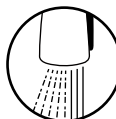

Dual function sprayer  
Douchette à double fonction

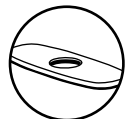

Optional deck plate  
Applique facultative



Lead free  
Sans plomb

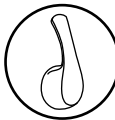

Metal lever handle  
Manette à levier en métal



Maximum flow rate of 1.75 gpm at 60 psi  
Débit maximum de 1,75 gpm à 60 psi

# Commercial Style Faucet

## Favos



3229-201  
FP4AF249CP



3229-203  
FP4AF249NP



3229-202  
FP4AF249BL

### Easy and Smart Features Les caractéristiques faciles et intelligentes

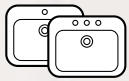

Fits 1 or 3 hole  
sinks

Pour éviers à 1  
ou 3 trous



Pull-down  
sprayer

Douchette  
extensible

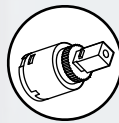

Ceramic disc  
cartridge

Cartouche  
de disque en  
céramique



Supply lines  
included

Conduites  
d'alimentation  
incluses



EZ ConX<sup>®</sup>  
Top Mount  
installation

EZ ConX<sup>MD</sup>  
Support de  
montage  
supérieur



Dual function  
sprayer

Douchette  
à double  
fonction

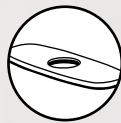

Optional deck  
plate

Applique  
facultative



Lead free  
Sans plomb



Metal lever  
handle

Manette à  
levier en métal

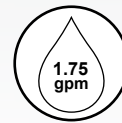

Maximum flow  
rate of 1.75  
gpm at 60 psi

Débit  
maximum de  
1,75 gpm à 60  
psi



## SINGLE HANDLE PULL-OUT KITCHEN FAUCET ROBINET DE CUISINE À UNE MANETTE AVEC DOUCHETTE RÉTRACTABLE



3227-001  
FP4A4053CP



3227-002  
FP4A4053NP



3229-139  
FP4A4054CP



3229-140  
FP4A4054NP



SINGLE HANDLE PULL-DOWN KITCHEN FAUCET  
 ROBINET DE CUISINE À UNE MANETTE AVEC DOUCHETTE EXTENSIBLE



3228-021  
 FP4AF278CP



3228-022  
 FP4AF278NP



3228-024  
 FP4AF279CP



3228-025  
 FP4AF279NP



3228-023  
 FP4AF279BL



3230-130  
 FP4A0118CP



3230-129  
 FP4A0118NP



3228-020  
 FP4A0118BL



3227-324  
 FP4A0118CZ



3229-201  
 FP4AF249CP



3229-203  
 FP4AF249NP



3229-202  
 FP4AF249BL



3227-320  
 FP1B4229CP



3227-321  
 FP1B4229BL



3227-322  
 FP1B4228CP



3227-323  
 FP1B4228BL



## SINGLE HANDLE KITCHEN FAUCET ROBINET DE CUISINE À UNE MANETTE



3230-658  
FS610003CP



3230-756  
FS610033CP

## TWO HANDLE KITCHEN FAUCET ROBINET DE CUISINE À DEUX MANETTES



3230-103  
F8FA0063CP



3230-108  
F8FA0053CP



3230-630  
F8F11096CP

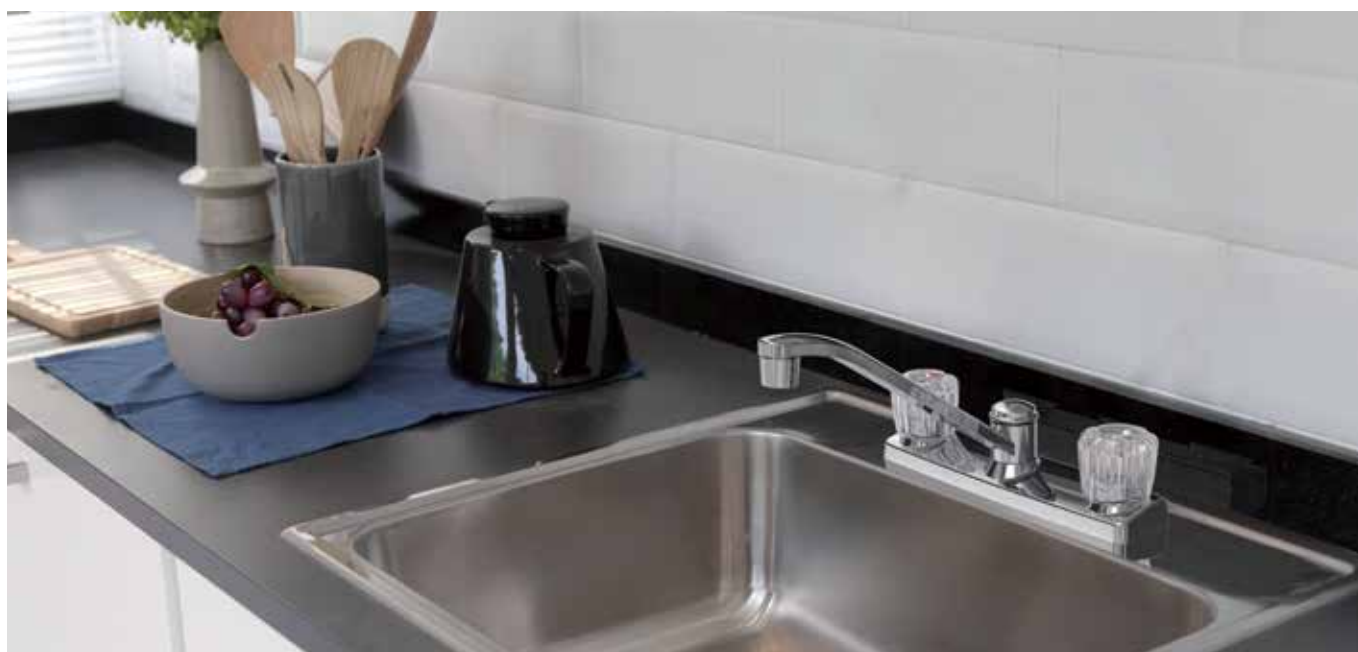



3230-100  
FS1B6000CP



3230-117  
F51A1136CP



3228-109  
FS1A9279CP



# Bathroom





## Easy and Smart Features / Les caractéristiques faciles et intelligentes

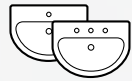

Fits 1 or 3 hole sinks

Pour lavabos 1 ou 3 trous

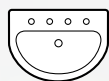

Fits 3 hole sinks, 6" - 12" centers

Pour lavabos 3 trous, entraxe de 6 à 12 po (15,2 à 30,5 cm)



Supply lines included

Conduites d'alimentation incluses



EZ ConX® Push pop-up drain assembly

Vidange à bonde-poussoir EZ ConX<sup>MD</sup>



EZ ConX® Hose connection

Raccord de tuyau EZ ConX<sup>MD</sup>

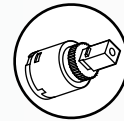

Ceramic disc cartridge

Cartouche de disque en céramique

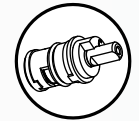

Ceramic disc cartridge

Cartouche en céramique

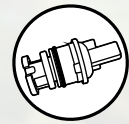

Washerless cartridge

Cartouche sans rondelle



Washerless stainless steel ball cartridge

Cartouche sans rondelle, à bille en acier inoxydable



Optional deck plate

Applique facultative



Lead free  
Sans plomb



Metal lever handle

Manette à levier en métal

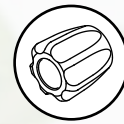

Acrylic handles  
Poignées en acrylique

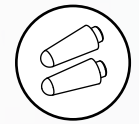

Porcelain lever handles with extra metal handles

Manettes à levier en porcelaine avec manettes supplémentaires en métal



Water saving aerator

Brise-jet économiseur d'eau



3 Hole installation

Installation à 3 trous

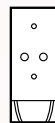

4 Hole installation

Installation à 4 trous



1 Setting showerhead

Pomme de douche à une fonction



Versitech shower valve

Corps de valve de versi avec butée

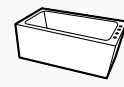

Fits 4 hole tubs

Pour baignoire à 4 trous

# Lavatory Faucet



# Adessa



3227-067  
FS6A0212CP



3227-066  
FS6A0212BL

## Easy and Smart Features Les caractéristiques faciles et intelligentes

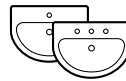

Fits 1 or 3 hole sinks  
Pour lavabos 1 ou 3 trous



Supply lines included  
Conduites d'alimentation incluses



EZ ConX® Push pop-up drain assembly  
Vidange à bonde-poussoir EZ ConX<sup>MD</sup>

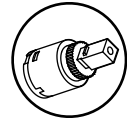

Ceramic disc cartridge  
Cartouche de disque en céramique



Lead free  
Sans plomb

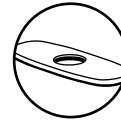

Optional deck plate  
Applique facultative

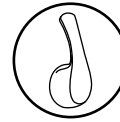

Metal lever handle  
Manette à levier en métal



Water saving aerator  
Brise-jet économiseur d'eau

# Possini



3227-064  
FS1A9278CP



3227-065  
FS1A9278NP



3227-063  
FS1A9278BL

## Easy and Smart Features / Les caractéristiques faciles et intelligentes

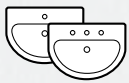

Fits 1 or 3 hole  
sinks  
Pour lavabos 1  
ou 3 trous



Supply lines  
included  
Conduites  
d'alimentation  
incluses



EZ ConX® Push  
pop-up drain  
assembly  
Vidange  
à bonde-  
poussoir  
EZ ConX<sup>MD</sup>

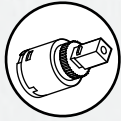

Ceramic disc  
cartridge  
Cartouche  
de disque en  
céramique



Lead free  
Sans plomb

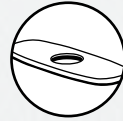

Optional deck  
plate  
Applique  
facultative



Metal lever  
handle  
Manette à  
levier en métal



Water saving  
aerator  
Brise-jet  
économiseur  
d'eau







# Capriza



3227-072  
FW6AC023CP

3227-073  
FW6AC023NP

3227-071  
FW6AC023BL

## Easy and Smart Features Les caractéristiques faciles et intelligentes

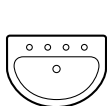

Fits 3 hole sinks, 6" - 12" centers  
Pour lavabos 3 trous, entraxe de 6 à 12 po (15,2 à 30,5 cm)



EZ ConX® Push pop-up drain assembly  
Vidange à bonde-poussoir EZ ConX<sup>MD</sup>



EZ ConX® Hose connection  
Raccord de tuyau EZ ConX<sup>MD</sup>

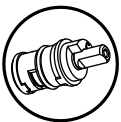

Ceramic disc cartridge  
Cartouche en céramique



Lead free  
Sans plomb

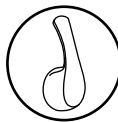

Metal lever handle  
Manette à levier en métal



Water saving aerator  
Brise-jet économiseur d'eau



## SINGLE HANDLE LAVATORY FAUCET ROBINET DE LAVABO À UNE MANETTE



3227-067  
FS6A0212CP



3227-066  
FS6A0212BL



3227-069  
FS6A0215CP



3227-070  
FS6A0215NP



3227-068  
FS6A0215BL



3227-090  
FS6A0215CZ



3227-064  
FS1A9278CP



3227-065  
FS1A9278NP



3227-063  
FS1A9278BL



3229-054  
F4510011CP



3227-957  
F41B4410CP

## PUSH POP-UP DRAIN DRAINS DE LAVABO



3270-115  
A505218CP



3270-116  
A505218NP



## TWO HANDLE LAVATORY FAUCET ROBINET DE LAVABO À DEUX MANETTES



**3230-114**  
F51A1044CP



**3230-112**  
F51A1044NP



**3230-550**  
F5121015CP



**3229-447**  
F51A1029CP



**3227-920**  
F5121026CP



**3230-747**  
F5110002CP

## TWO HANDLE WIDESPREAD LAVATORY FAUCET ROBINET DE LAVABO À DEUX MANETTES ÉVASÉS



**3227-072**  
FW6AC023CP



**3227-073**  
FW6AC023NP



**3227-071**  
FW6AC023BL



3230-102  
F2010512CP



3227-062  
F12A0005CP



3227-058  
F1A1F507CP



3227-057  
F1A1F507BL



3227-060  
F12A0006CP



3227-061  
F12A0006NP



3227-059  
F12A0006BL



3230-109  
FR2B0006CP



3267-000  
S1254G04CF



3267-001  
S1254G04NF













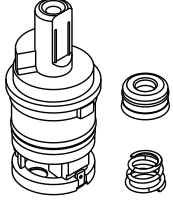

3267-003  
S2254G26CP

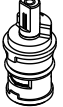
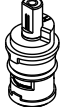

3267-004  
S2254G26NP

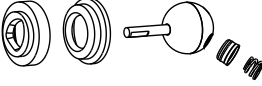

Layout and Placement of Parts / Positionnement des pièces

 Aerator/Brise-jet (1pcs) #A500549NCP-50	 Aerator/Brise-jet (1pcs) #A500871NCP-51	 Seat and Spring set/Siège et ensemble Ressort (8 pairs) #A663002			 Washerless Cartridge Assembly/ Cartouche sans rondelle (4 pcs) #A66D636N
 O-ring Set/ Ensemble du joint torique (3 pairs) #A668000N	 Index Button-Hot / Repère de température-chaud (3 pairs) #A66D674HCP	 Index Button-Cold/ Repère de température-froid (3 pairs) #A66D674CCP	 Ceramic Cartridge-Cold/ Cartouche ceramique-Froid (1 pcs) #A507004N	 Ceramic Cartridge-Hot/ Cartouche ceramique-Froid (1 pcs) #A507003N	
 O-ring Set/ Ensemble du joint torique (3 pairs) #A608220	 Handle Cap/Capuchon (3 pairs) #A66D749CP	 Handle Cap/Capuchon (2 pairs) 206041CCP+ 206041HCP	 Handle Cap/Capuchon (2pairs) 206041CNP+ 206041HNP	 Ceramic Cartridge/ Cartouche ceramique (1 pcs) #A507348N	
 Acrylic Handle/Manettes Acrylique (2pcs) #A029001	 Ball Valve Assembly/Assemblage de bille (3pcs) #A66D641N				

**Eurostream PARTS KIT 8920-035**

•Available from your DC

**Kit des pièces de rechange pour Eurostream 8920-035**

•Disponible à partir de votre centre de distribution

**Customer Support: 1-800-487-8372**

**Hours of Operation**

**Monday – Friday: 8am – 8pm EST**

**Saturday: 9am – 6pm EST**

**Soutien à la clientèle : 1-800-487-8372**

**Les heures d'ouverture**

**Lundi au vendredi : 8h à 20h HNE**

**Samedi : 9h à 18h HNE**

<p><b>eurostream</b></p> <p><b>LIMITED LIFETIME WARRANTY</b></p> <p><b>Eurostream Limited Lifetime Warranty</b></p> <p>All parts of the Eurostream faucet are warranted to the original consumer purchaser to be free from defects in material and workmanship, for as long as the consumer purchaser owns it.</p> <p>Eurostream will replace "free of charge", during the warranty period, any part that proves to be defective in material and/or workmanship under normal residential application. Avoid abrasive cleaners, steel wool and harsh chemicals. These will dull the finish and void your warranty.</p> <p><b>THIS WARRANTY IS LIMITED TO REPLACEMENT PARTS ONLY AND DOES NOT COVER OR INCLUDE LABOR CHARGES OR DAMAGE INCURRED IN INSTALLATION, REPAIR OR REPLACEMENT OR ANY INCIDENTAL OR CONSEQUENTIAL DAMAGES WHATSOEVER, NOR DOES IT COVER OR INCLUDE DAMAGES FOR PERSONAL INJURY, PROPERTY DAMAGE OR ECONOMIC LOSS.</b></p> <p>Any damage to this product as a result of improper installation, misuse, accident, neglect or any use that violates the instructions furnished by us, WILL VOID WARRANTY IMMEDIATELY. This warranty is only valid to the original consumer purchaser and excludes industrial, commercial or business use of the product.</p> <p><b>ANY DAMAGE CLAIMS MUST BE MADE IN WRITING, ACCOMPANIED BY THE DEFECTIVE PART ALONG WITH THE ORIGINAL PROOF OF PURCHASE, AND DELIVERED TO EUROSTREAM, C/O GLOBE UNION CANADA INC., 4610 BOIS FRANC, MONTREAL, QUEBEC, CANADA H4S 1A7</b></p> <p>Call Eurostream CUSTOMER SERVICE LINE for assistance regarding your Eurostream faucet or warranty.</p> <p><b>1-800-487-8372 6 days a week MON.-FRI.: 8:00AM-8:00PM EST SAT. : 9:00AM-6:00PM (VERSO)</b></p>	<p><b>eurostream</b></p> <p><b>GARANTIE LIMITÉE À VIE</b></p> <p><b>Garantie limitée à vie d'Eurostream</b></p> <p>Toutes les pièces du robinet Eurostream sont garanties à vie contre tout défaut de fabrication, à compter de la date d'achat apparaissant sur le reçu de l'acheteur. Seul l'acheteur consommateur initial peut se prévaloir de cette garantie.</p> <p>Eurostream remplacera « sans frais », au cours de la période de garantie, toute pièce qui présentera un défaut de fabrication et ce, suite à un usage résidentiel normal. Éviter d'utiliser des nettoyants abrasifs, des produits chimiques et de la laine d'acier qui risquent d'endommager le fini et d'annuler votre garantie.</p> <p><b>CETTE GARANTIE SE LIMITE AUX PIÈCES DE REMPLACEMENT SEULEMENT, CELLE-CI NE COUVRE PAS ET NE COMPREND PAS LES FRAIS DE MAIN-D'ŒUVRE ET OU LES DOMMAGES QUI SURVIENNENT LORS DE L'INSTALLATION, DE LA RÉPARATION OU DU REMPLACEMENT ET LES DOMMAGES FORTUITS OU INDIRECTS QUELS QU'ILS CE SOIENT. ELLE NE COUVRE PAS ET NE COMPREND PAS NON PLUS LES DOMMAGES ET INTÉRÊTS EN CAS DE BLESSURES CORPORELLES, DE DOMMAGES À LA PROPRIÉTÉ OU DE PERTES FINANCIÈRES.</b></p> <p>Si ce produit est endommagé suite à une installation inadéquate, un accident, de la négligence ou toute autre utilisation qui enfreint les instructions que nous vous fournissons, LA GARANTIE S'ANNULERA IMMÉDIATEMENT. Cette garantie s'applique au premier acheteur consommateur seulement et exclut l'usage industriel, commercial ou d'affaires du produit.</p> <p><b>TOUTE RÉCLAMATION DE DOMMAGE DOIT ÊTRE FAITE PAR ÉCRIT ET ACCOMPAGNÉE DE LA PIÈCE DÉFECTUEUSE, D'UNE PREUVE D'ACHAT (ORIGINALE) ET EXPÉDIÉE À EUROSTREAM, A/S GLOBE UNION CANADA INC., 4610 BOIS FRANC, MONTREAL, QUEBEC, CANADA H4S 1A7</b></p> <p>Utilisez la ligne de service à la clientèle pour obtenir de l'aide concernant votre produit ou votre garantie Eurostream</p> <p><b>1-800-487-8372 6 Jours par semaine Lundi au Vendredi: 8h-20h Est Samedi : 9h-18h (ENGLISH ON REVERSE)</b></p>
--	---

# euroStream™



4610 Bois Franc, Montreal, Quebec H4S 1A7

Customer Support: 1-800-487-8372  
Hours of Operation  
Monday – Friday: 8am – 8pm EST  
Saturday: 9am – 6pm EST

Soutien à la clientèle : 1-800-487-8372  
Les heures d'ouverture  
Lundi au vendredi : 8h à 20h HNE  
Samedi : 9h à 18h HNE